



# Aluminum electrolytic capacitors

## Snap-in capacitors

**Series/Type:** B41607  
**Date:** December 2006

### Long-life grade capacitors

#### Applications

- High-reliability equipment in automotive power electronics, e.g. integrated starter alternator
- Applications with highest ripple current load at high frequencies

#### Features

- Outstanding reliability and long useful life, up to 2000 h at 150 °C
- Very high ripple current capability optimized for high frequencies
- Vibration resistance up to 40 g
- Shelf life up to 15 years at storage temperatures up to 40 °C. To ensure solderability, the capacitors should be built into the application within one year of delivery. After a total of two years' storage, the operating voltage must be applied for one hour to ensure the specified leakage current.

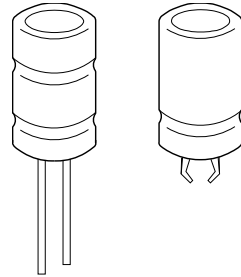

#### Construction

- Charge/discharge-proof, polar
- Aluminum case, fully insulated
- Up to 40 g vibration stability version with wired terminals and corrugation
- Snap-in solder version with pins to hold component in place on PC-board
- Minus pole not insulated from case
- Overload protection (safety vent)
- Without insulation sleeve upon request

#### Terminals

- Standard vibration version with wired terminals, weldable and solderable
- Snap-in with 3 terminals, protection against polarity reversal
- Up to 40 g vibration stability version with wired terminals, weldable and solderable

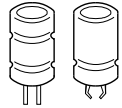
**Specifications and characteristics in brief**

Rated voltage $V_R$	25 ... 63 V DC	
Surge voltage $V_S$	$1.15 \cdot V_R$	
Rated capacitance $C_R$	800 ... 4700 $\mu$ F	
Capacitance tolerance	$\pm 20\% \triangleq M$	
Leakage current $I_{leak}$ (5 min, 20 °C)	$I_{leak} \leq 0.006 \mu A \cdot \left( \frac{C_R}{\mu F} \cdot \frac{V_R}{V} \right) + 4 \mu A$	
Self-inductance ESL	15 nH	
Useful life	Requirements:	
150 °C, $V_R$ , $0.5 \cdot I_{AC,R}$	> 2000 h	$\Delta C/C \leq \pm 30\%$ of initial value
125 °C, $V_R$ , $I_{AC,R}$	> 10000 h	ESR $\leq 3$ times initial specified limit
85 °C, $V_R$ , $2.1 \cdot I_{AC,R}$	> 30000 h	$I_{leak} \leq$ initial specified limit
40 °C, $V_R$ , $2.1 \cdot I_{AC,R}$	> 500000 h	
Voltage endurance test	Post test requirements:	
125 °C, $V_R$	5000 h	$\Delta C/C \leq \pm 10\%$ of initial value
		ESR $\leq 1.3$ times initial specified limit
		$I_{leak} \leq$ initial specified limit
Vibration resistance test	To IEC 60068-2-6, test Fc:	
	40 g vibration stability version	Snap-in version with 3 terminals and version with wired terminals
	Displacement amplitude 3 mm, frequency range 10 Hz ... 2 kHz, acceleration max. 40 g, duration $3 \times 2$ h. Capacitor mounted by its body which is rigidly clamped to the work surface.	Displacement amplitude 0.75 mm, frequency range 10 Hz ... 2 kHz, acceleration max. 10 g, duration $3 \times 2$ h. Capacitor mounted by its body which is rigidly clamped to the work surface.
IEC climatic category	To IEC 60068-1: 55/125/56 (–55 °C/+ 125 °C/56 days damp heat test)	
Detail specification	Similar to CECC 30301-809	
Sectional specification	IEC 60384-4	

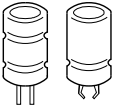

**B41607**

**Automotive – up to 150 °C**

**Dimensional drawings**

**Large-size capacitor, up to 40 g vibration stability version with wired terminals**

\*) Permissible range of positions for minus pole marking

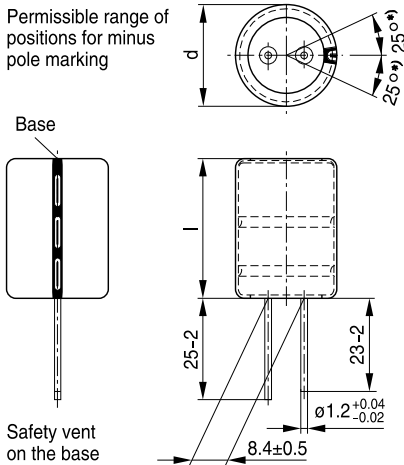

KAL0962-U-E

**Dimensions and weights**

Dimension (mm)		Approx. weight (g)
d +1	l ±2	
22	40	21
25	40	28
25	50	35

Packing units upon request.

**Large-size capacitor, standard vibration version with wired terminals**

\*) Permissible range of positions for minus pole marking

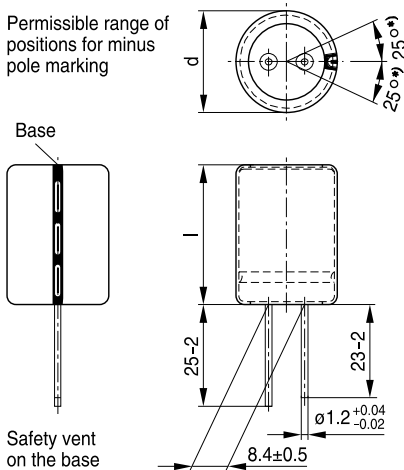

KAL1078-1

**Dimensions and weights**

Dimension (mm)		Approx. weight (g)
d +1	l ±2	
22	40	21
25	40	28
25	50	35

Packing units upon request.

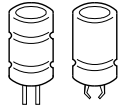

### Large size capacitor, snap-in version with 3 terminals

#### Dimensions, weights and packing units

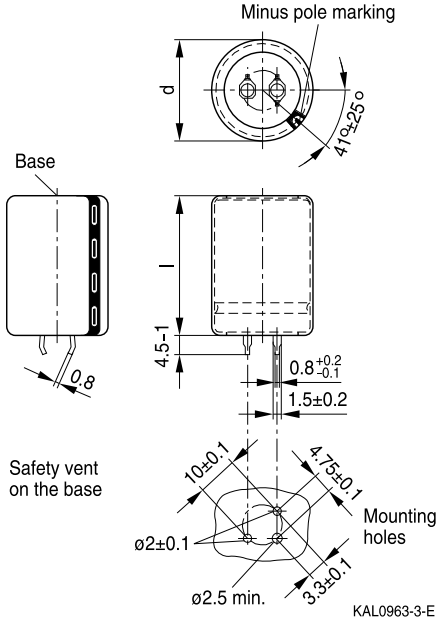

Dimensions (mm)		Approx. weight (g)	Packing units (pcs.)
$d + 1$	$l \pm 2$		
22	40	21	160
25	40	28	130
25	50	35	130

#### Packing of snap-in capacitors



For ecological reasons the packing is pure cardboard. Components can be withdrawn (in full or in part) in the correct position for insertion.

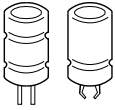

**B41607**

**Automotive – up to 150 °C**

**Overview of available types**

$V_R$ (V DC)	25	40	55	63
	Case dimensions $d \times l$ (mm)			
$C_R$ ( $\mu$ F)				
800				22 × 40
1100			22 × 40	25 × 40
1500		22 × 40	25 × 40	25 × 50
2000		25 × 40	25 × 50	
2500	22 × 40			
2700		25 × 50		
3300	25 × 40			
4700	25 × 50			

The capacitance and voltage ratings listed above are available in different cases upon request. Other voltage and capacitance ratings are also available upon request.

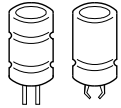

**Case dimensions and ordering codes**

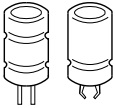
$V_R$	$C_R$ 100 Hz 20 °C V DC $\mu\text{F}$	Case dimensions $d \times l$ mm	Ordering code Snap-in version with 3 terminals	Ordering code Version with wired terminals	Ordering code Up to 40 g vibration stability version with wired terminals
25	2500	22 × 40	B41607A5258M002	B41607A5258M008	B41607A5258M009
	3300	25 × 40	B41607A5338M002	B41607A5338M008	B41607A5338M009
	4700	25 × 50	B41607A5478M002	B41607A5478M008	B41607A5478M009
40	1500	22 × 40	B41607A7158M002	B41607A7158M008	B41607A7158M009
	2000	25 × 40	B41607A7208M002	B41607A7208M008	B41607A7208M009
	2700	25 × 50	B41607A7278M002	B41607A7278M008	B41607A7278M009
55	1100	22 × 40	B41607A0118M002	B41607A0118M008	B41607A0118M009
	1500	25 × 40	B41607A0158M002	B41607A0158M008	B41607A0158M009
	2000	25 × 50	B41607A0208M002	B41607A0208M008	B41607A0208M009
63	800	22 × 40	B41607A8807M002	B41607A8807M008	B41607A8807M009
	1100	25 × 40	B41607A8118M002	B41607A8118M008	B41607A8118M009
	1500	25 × 50	B41607A8158M002	B41607A8158M008	B41607A8158M009

**B41607**
**Automotive – up to 150 °C**
**Technical data**

$C_R$	ESR <sub>typ</sub>	ESR <sub>max</sub>	ESR <sub>max</sub>	ESR <sub>max</sub>	Z <sub>max</sub>	I <sub>AC,max</sub>	I <sub>AC,R</sub>	I <sub>AC,max</sub>
100 Hz	100 Hz	100 Hz	100 Hz	10 kHz	100 kHz	10 kHz	10 kHz	10 kHz
20 °C	20 °C	20 °C	-40 °C	20 °C	20 °C	105 °C	125 °C	150 °C
μF	mΩ	mΩ	mΩ	mΩ	mΩ	A	A	A
<b>V<sub>R</sub> = 25 V DC</b>								
2500	22	32	115	22	22	10.7	5.6	2.8
3300	16	22	80	15	15	14.5	7.6	3.8
4700	12	17	60	11	11	18.5	9.7	4.9
<b>V<sub>R</sub> = 40 V DC</b>								
1500	31	42	115	22	21	10.5	5.5	2.8
2000	19	27	80	14	14	14.6	7.7	3.8
2700	15	21	60	11	11	18.5	9.7	4.9
<b>V<sub>R</sub> = 55 V DC</b>								
1100	35	49	115	22	21	10.5	5.5	2.8
1500	22	32	80	14	14	14.6	7.7	3.8
2000	17	24	60	11	11	18.5	9.8	4.9
<b>V<sub>R</sub> = 63 V DC</b>								
800	40	56	115	22	22	10.3	5.4	2.7
1100	27	38	90	14	14	14.5	7.6	3.8
1500	20	28	65	11	11	18.5	9.7	4.9

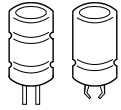



### Useful life

depending on ambient temperature  $T_A$  under ripple current operating conditions at  $V_R^{1)}$

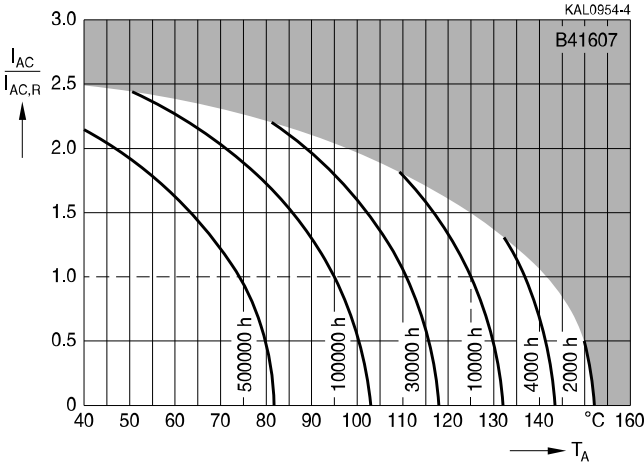

### Useful life

depending on case temperature  $T_C$  under ripple current operating conditions at  $V_R^{1)}$

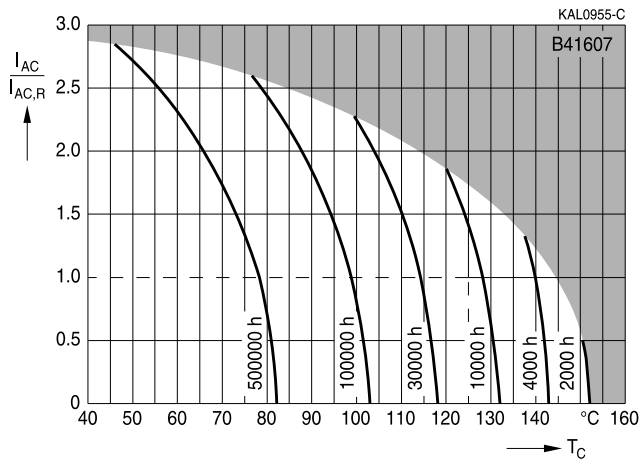

1) Refer to chapter "General technical information, 5.3 Calculation of useful life" for an explanation on how to interpret the useful life graphs

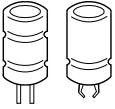

**B41607**

**Automotive – up to 150 °C**

**Frequency factor of permissible ripple current  $I_{AC}$  versus frequency  $f$**

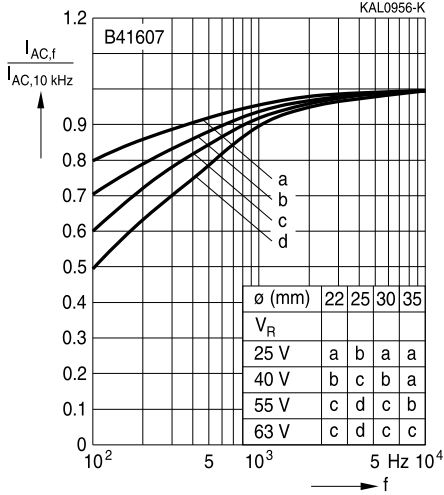

**Frequency characteristics of ESR**  
Typical behavior

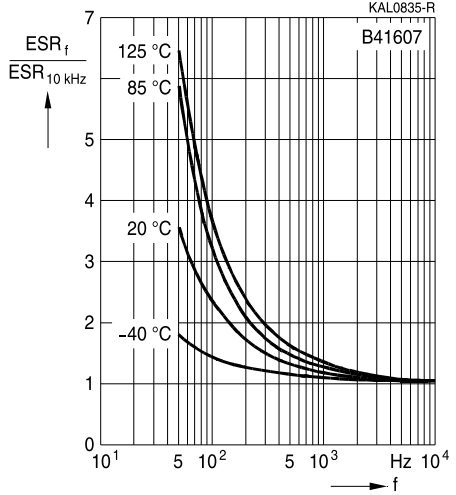

**Equivalent series resistance ESR versus frequency  $f$**

Typical behavior for 1500  $\mu$ F/55 V

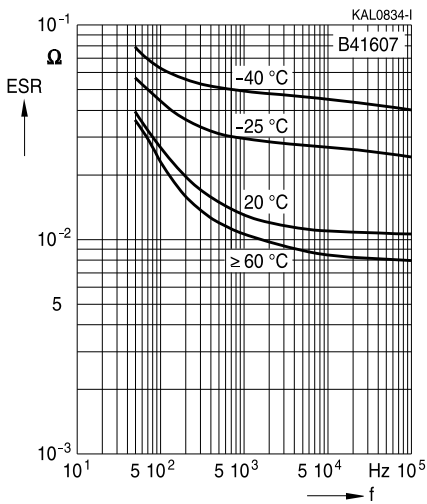

**Impedance  $Z$  versus frequency  $f$**

Typical behavior for 1500  $\mu$ F/55 V

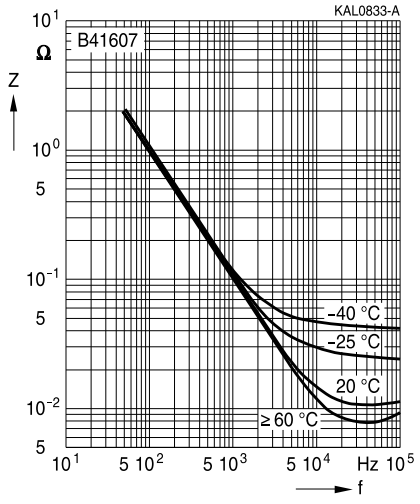

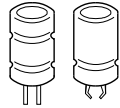

## Cautions and warnings

### Personal safety

The electrolytes used by EPCOS have not only been optimized with a view to the intended application, but also with regard to health and environmental compatibility. They do not contain any solvents that are detrimental to health, e.g. dimethyl formamide (DMF) or dimethyl acetamide (DMAC).

Furthermore, part of the high-voltage electrolytes used by EPCOS are self-extinguishing. They contain flame-retarding substances which will quickly extinguish any flame that may have been ignited.

As far as possible, EPCOS does not use any dangerous chemicals or compounds to produce operating electrolytes. However, in exceptional cases, such materials must be used in order to achieve specific physical and electrical properties because no safe substitute materials are currently known. However, the amount of dangerous materials used in our products has been limited to an absolute minimum. Nevertheless, the following rules should be observed when handling Al electrolytic capacitors:

- Any escaping electrolyte should not come into contact with eyes or skin.
- If electrolyte does come into contact with the skin, wash the affected parts immediately with running water. If the eyes are affected, rinse them for 10 minutes with plenty of water. If symptoms persist, seek medical treatment.
- Avoid breathing in electrolyte vapor or mists. Workplaces and other affected areas should be well ventilated. Clothing that has been contaminated by electrolyte must be changed and rinsed in water.

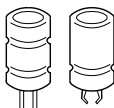
**B41607**
**Automotive – up to 150 °C**

### Product safety

The table below summarize the safety instructions that must be observed without fail. A detailed description can be found in the relevant sections of chapter "General technical information".

Topic	Safety information	Reference Chapter "General technical information"
Polarity	Make sure that polar capacitors are connected with the right polarity.	1 "Basic construction of aluminum electrolytic capacitors"
Reverse voltage	Voltages polarity classes should be prevented by connecting a diode.	3.1.6 "Reverse voltage"
Upper category temperature	Do not exceed the upper category temperatur.	7.2 "Maximum permissible operating temperature"
Maintenance	Make periodic inspections of the capacitors. Before the inspection, make sure that the power supply is turned off and carefully discharge the electricity of the capacitors. Do not apply any mechanical stress to the capacitor terminals.	10 "Maintenance"
Mounting position of screw terminal capacitors	Do not mount the capacitor with the terminals (safety vent) upside down.	11.1. "Mounting positions of capacitors with screw terminals"
Mounting of single-ended capacitors	The internal structure of single-ended capacitors might be damaged if excessive force is applied to the lead wires. Avoid any compressive, tensile or flexural stress. Do not move the capacitor after soldering to PC board. Do not pick up the PC board by the soldered capacitor. Do not insert the capacitor on the PC board with a hole space different to the lead space specified.	11.4 "Mounting considerations for single-ended capacitors"
Robustness of terminals	The following maximum tightening torques must not be exceeded when connecting screw terminals: M5: 2 Nm M6: 2.5 Nm	11.3 "Mounting torques"
Soldering	Do not exceed the specified time or temperature limits during soldering.	11.5 "Soldering"

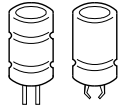

Topic	Safety information	Reference Chapter "General technical information"
Soldering, cleaning agents	Do not allow halogenated hydrocarbons to come into contact with aluminum electrolytic capacitors.	11.6 "Cleaning agents"
Passive flammability	Avoid external energy, such as fire or electricity.	8.1 "Passive flammability"
Active flammability	Avoid overload of the capacitors.	8.2 "Active flammability"
		Reference Chapter "Capacitors with screw terminals"
Breakdown strength of insulating sleeves	Do not damage the insulating sleeve, especially when ring clips are used for mounting.	"Screw terminals - accessories"

## Important notes

The following applies to all products named in this publication:

1. Some parts of this publication contain **statements about the suitability of our products for certain areas of application**. These statements are based on our knowledge of typical requirements that are often placed on our products in the areas of application concerned. We nevertheless expressly point out **that such statements cannot be regarded as binding statements about the suitability of our products for a particular customer application**. As a rule, EPCOS is either unfamiliar with individual customer applications or less familiar with them than the customers themselves. For these reasons, it is always ultimately incumbent on the customer to check and decide whether an EPCOS product with the properties described in the product specification is suitable for use in a particular customer application.
2. We also point out that **in individual cases, a malfunction of passive electronic components or failure before the end of their usual service life cannot be completely ruled out in the current state of the art, even if they are operated as specified**. In customer applications requiring a very high level of operational safety and especially in customer applications in which the malfunction or failure of a passive electronic component could endanger human life or health (e.g. in accident prevention or life-saving systems), it must therefore be ensured by means of suitable design of the customer application or other action taken by the customer (e.g. installation of protective circuitry or redundancy) that no injury or damage is sustained by third parties in the event of malfunction or failure of a passive electronic component.
3. **The warnings, cautions and product-specific notes must be observed.**
4. In order to satisfy certain technical requirements, **some of the products described in this publication may contain substances subject to restrictions in certain jurisdictions (e.g. because they are classed as “hazardous”)**. Useful information on this will be found in our Material Data Sheets on the Internet ([www.epcos.com/material](http://www.epcos.com/material)). Should you have any more detailed questions, please contact our sales offices.
5. We constantly strive to improve our products. Consequently, **the products described in this publication may change from time to time**. The same is true of the corresponding product specifications. Please check therefore to what extent product descriptions and specifications contained in this publication are still applicable before or when you place an order. We also **reserve the right to discontinue production and delivery of products**. Consequently, we cannot guarantee that all products named in this publication will always be available.
6. Unless otherwise agreed in individual contracts, **all orders are subject to the current version of the “General Terms of Delivery for Products and Services in the Electrical Industry” published by the German Electrical and Electronics Industry Association (ZVEI)**.
7. The trade names EPCOS, EPCOS-JONES, BAOKE, Alu-X, CeraDiode, CSSP, MLSC, PhaseCap, PhaseMod, SIFERRIT, SIFI, SIKOREL, SilverCap, SIMID, SIOV, SIP5D, SIP5K, UltraCap, WindCap are **trademarks registered or pending** in Europe and in other countries. Further information will be found on the Internet at [www.epcos.com/trademarks](http://www.epcos.com/trademarks).